

少年男子シングルス (BS)

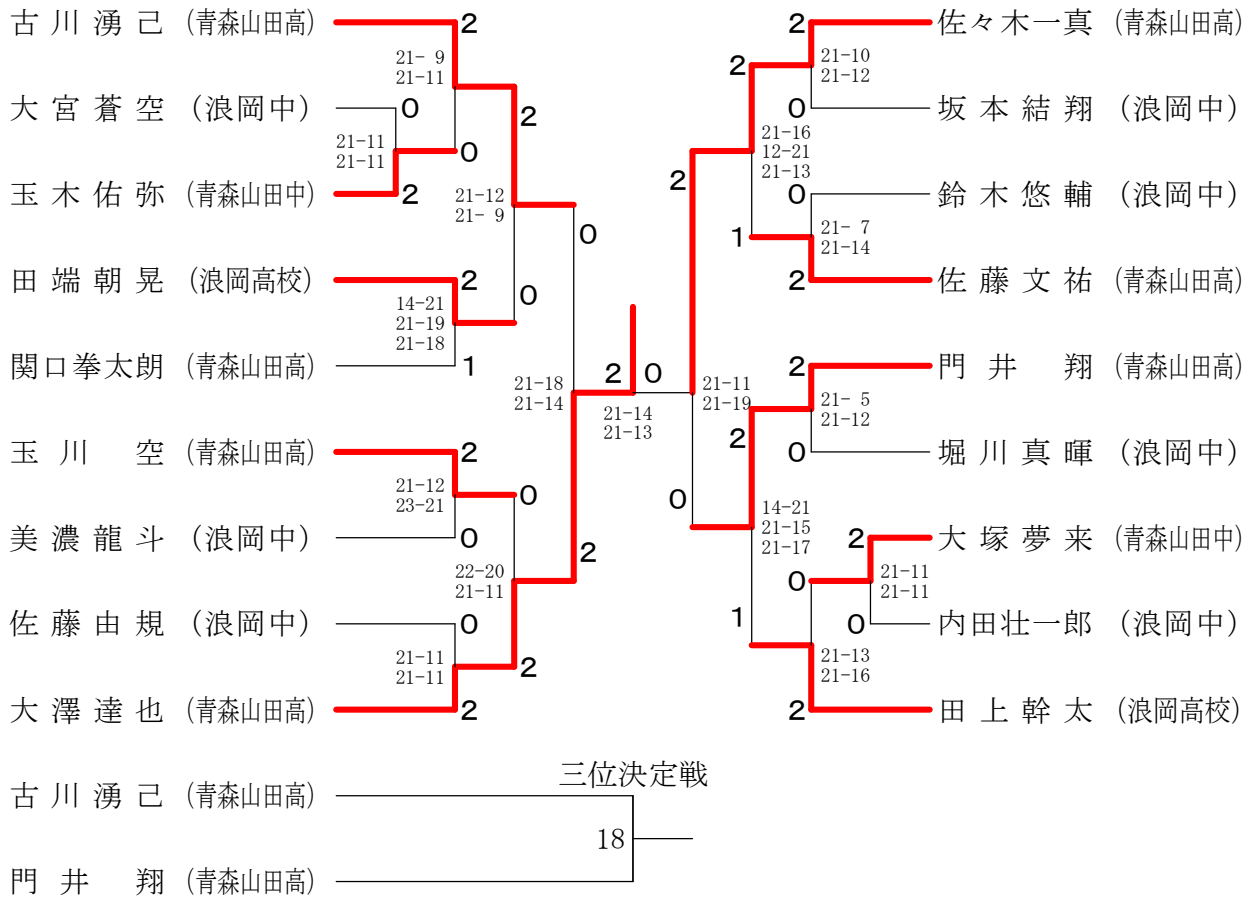

少年女子シングルス (GS)

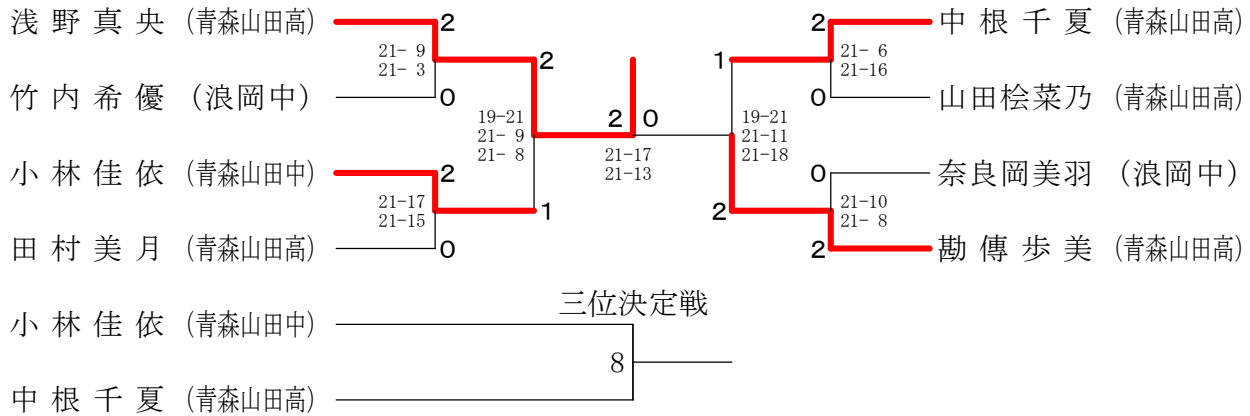

成年男子ダブルス (MD)

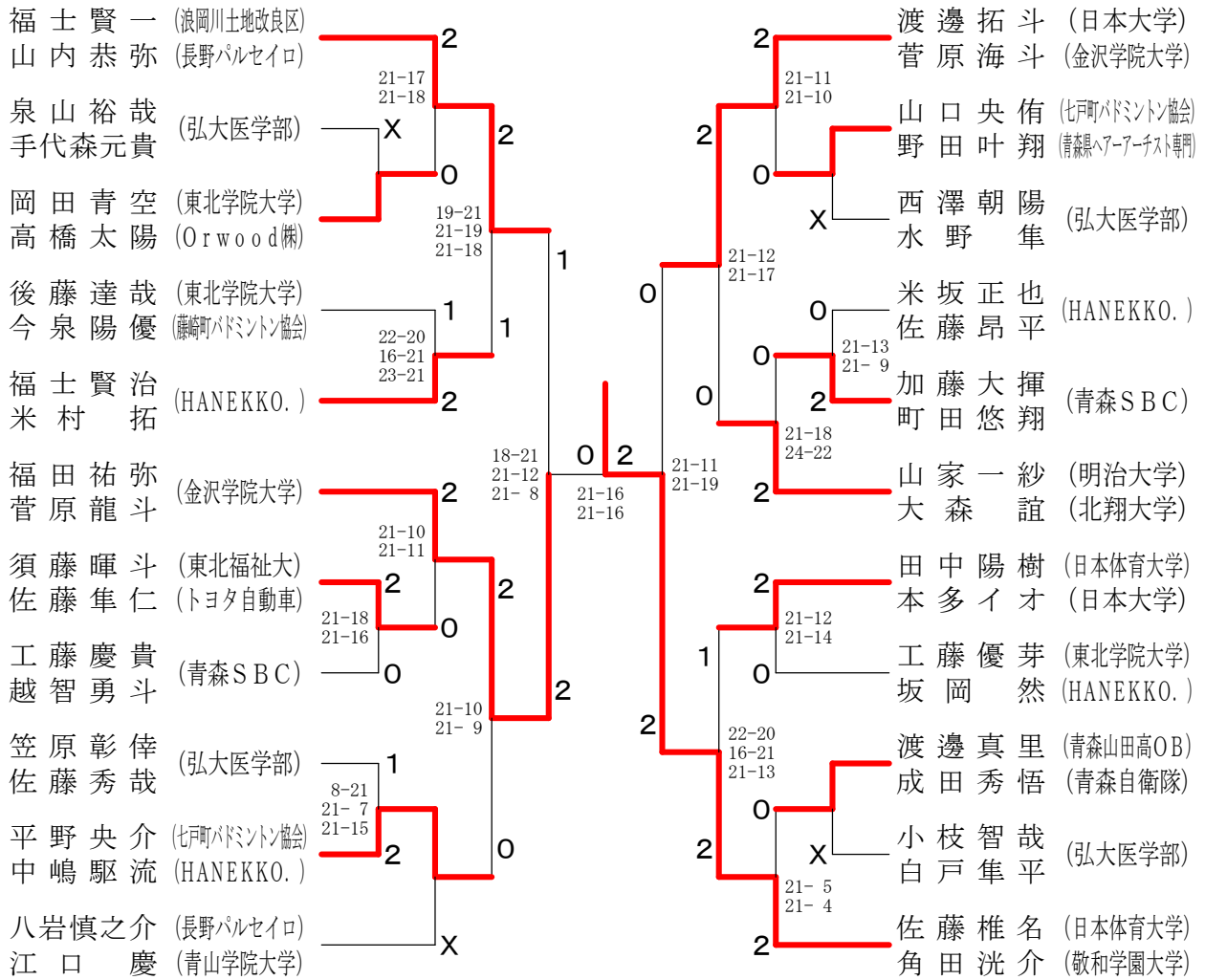

成年女子ダブルス (LD)

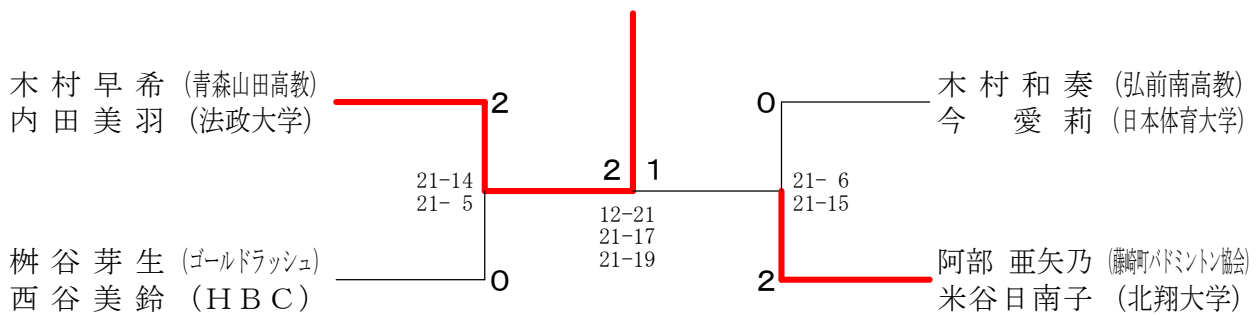

成年男子シングルス (MS)

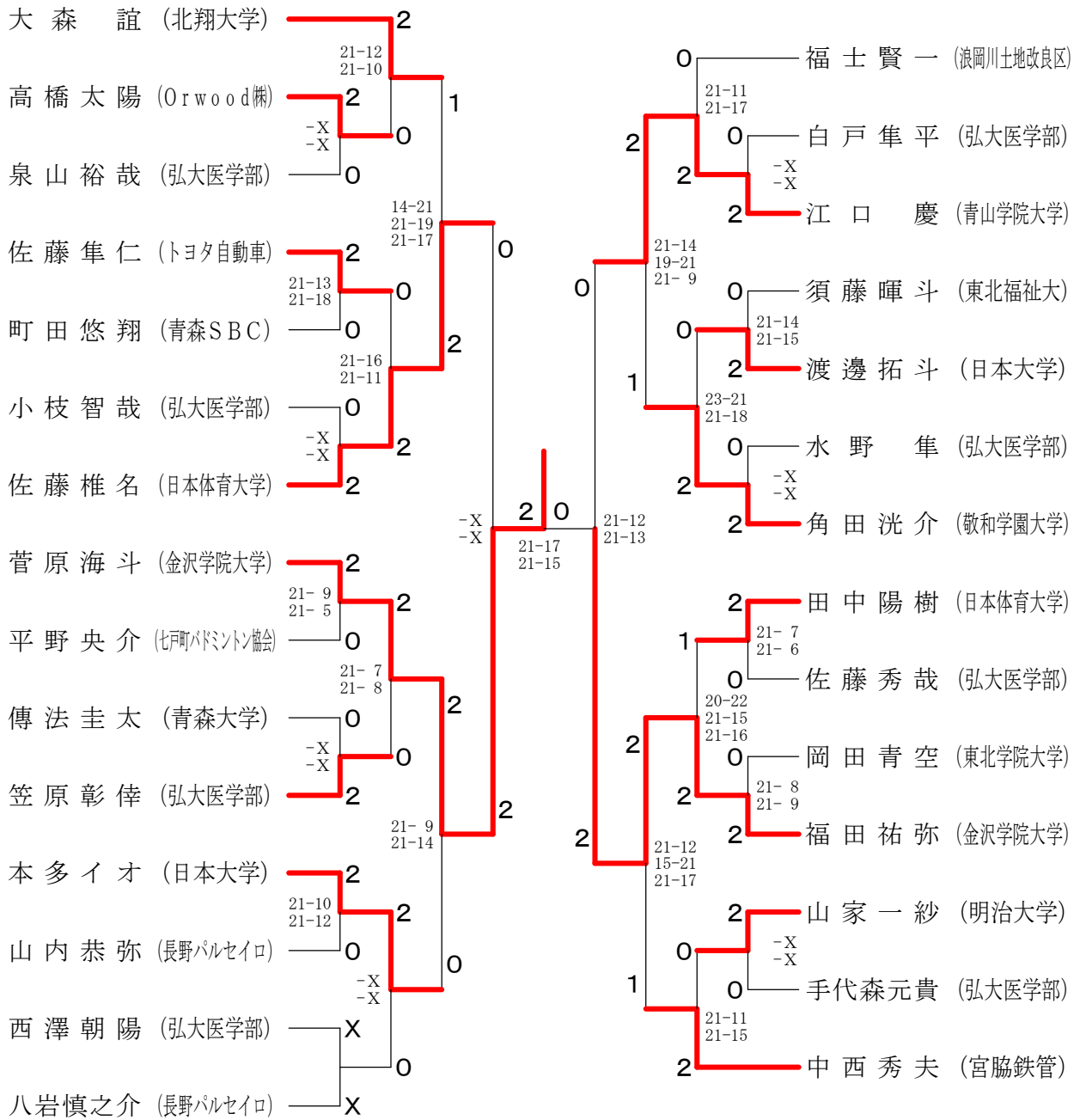

三位決定戦

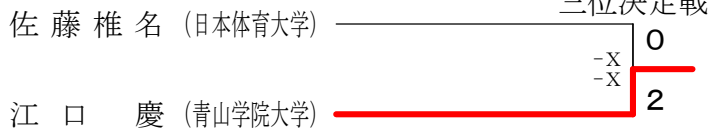

成年女子シングルス (LS)

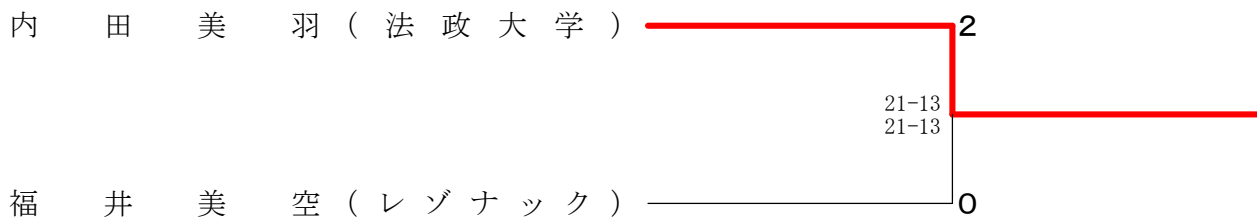

30歳以上男子ダブルス (30MD)

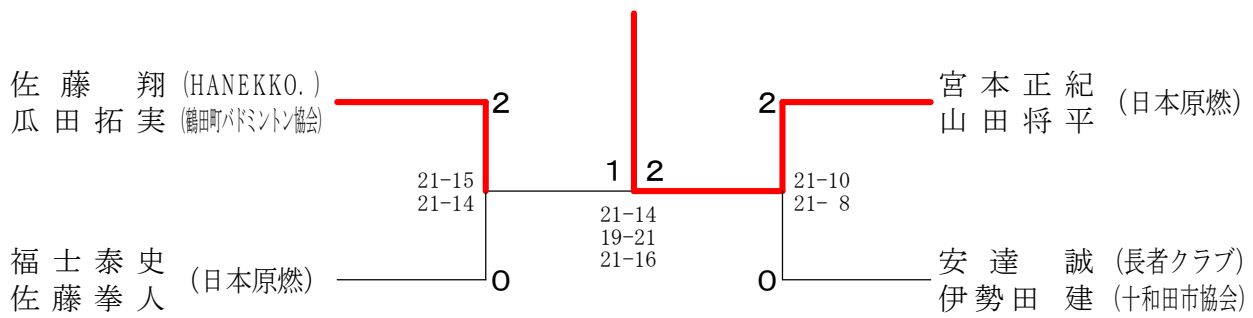

30歳以上男子シングルス (30MS)

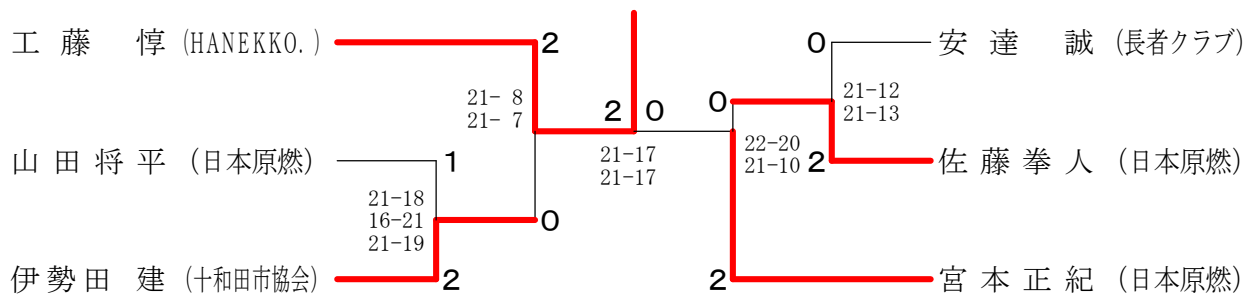

40歳以上男子ダブルス (40MD)

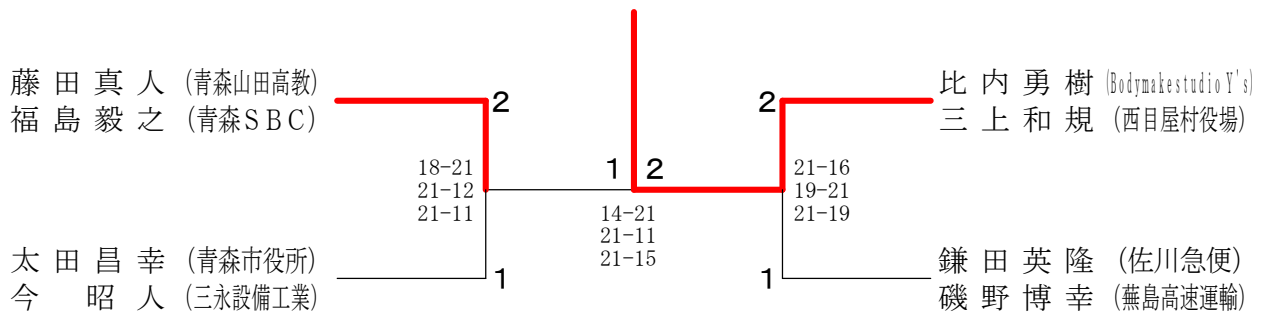

40歳以上男子シングルス (40MS)

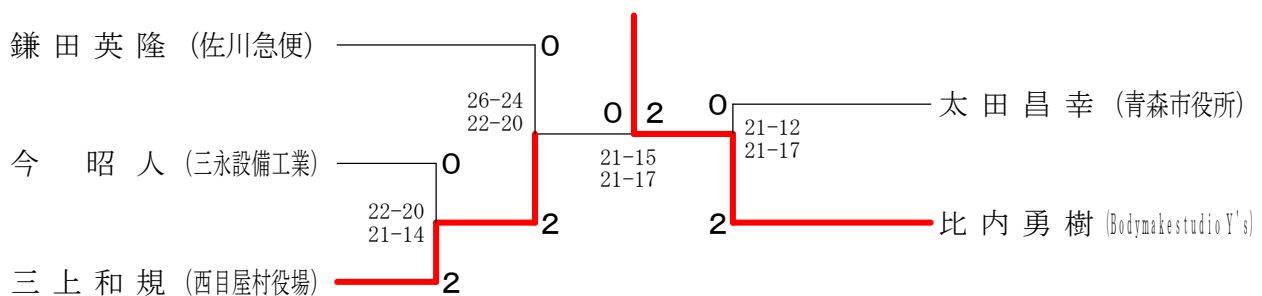

50歳以上男子ダブルス (50MD)

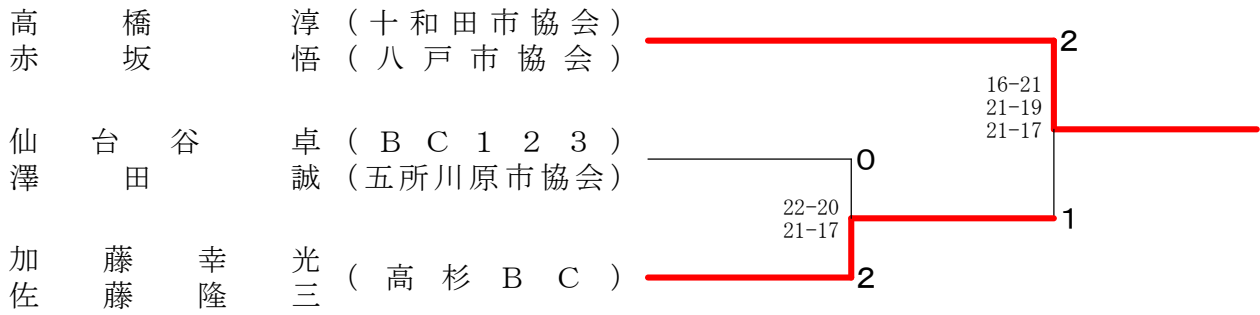

混合ダブルス (XD)

